

REDMOND

Multicooker
SkyCooker RMC-M92S



User manual

CONTENTS

IMPORTANT SAFEGUARDS.....	8	Standard Operating Procedure for Automatic Programs.....	11
Technical Specifications	9	Table of Default Settings.....	12
Programs	9	III. ADDITIONAL FEATURES	12
Functions.....	9	IV. COOKING TIPS	12
Package includes	9	Common Cooking Mistakes and Ways of Solving Them.....	12
Multicooker parts.....	9	Recommended Steaming Time Settings For Various Products	13
Control panel	9	Recommended Temperatures in “МУЛЬТИПОВАР”	14
Display	9	V. CLEANING AND MAINTENANCE.....	14
I. PRIOR TO FIRST USE	9	General Guidelines.....	14
II. OPERATION	10	To Clean Inner Aluminium lid.....	14
The Ready for Sky technology.....	10	To Clean Removable Steam Valve	14
Non-volatile memory.....	10	To Remove Condensate	14
Setting The Cooking Time	10	Transportation and Storage	15
Time Delay Function	11	VI. ADDITIONAL ACCESSORIES.....	15
Keep Warm Function	11	VII. BEFORE CONTACTING SERVICE CENTER	15
Disabling The Keep Warm In Advance	11		
Reheat Function	11		

Manufacturer: Power Point Inc Limited №1202 Hai Yun Ge (B1) Lin Hai Shan Zhuang Xiamelin Futian Shenzhen China. 518049. Under license of REDMOND®
Производитель: Пауэр Пойнт Инк. Лимитед №1202 Хай Юн Ге (B1) Лин Хай Шан Чжуан Сямейлин Футьян, Шеньжень, Китай, 518049. По лицензии REDMOND®
Виробник: Пауэр Пойнт Інк.Лімітед № 1202 Хай Юн Ге (B1) Лін Хай Шан Чжуан Сямейлін Футьян, Шеньжень, Китай, 518049. За ліцензією REDMOND®

Importer (EU): SIA SPILVA TRADING Address: Jelgava, Meiju cels 43 – 62, LV-3007 Reg. Nr. 43603078598. **CY Importer** Cyprus: ASBIS Kypros Limited; 26, Spyrou Kyprianou Str, 4040, Germa-
sogeia, Limassol, Cyprus. Tel: +357 25 257 350; Fax: +357 25 322 432, e-mail: info@asbis.com.cy; www.asbis.com.cy

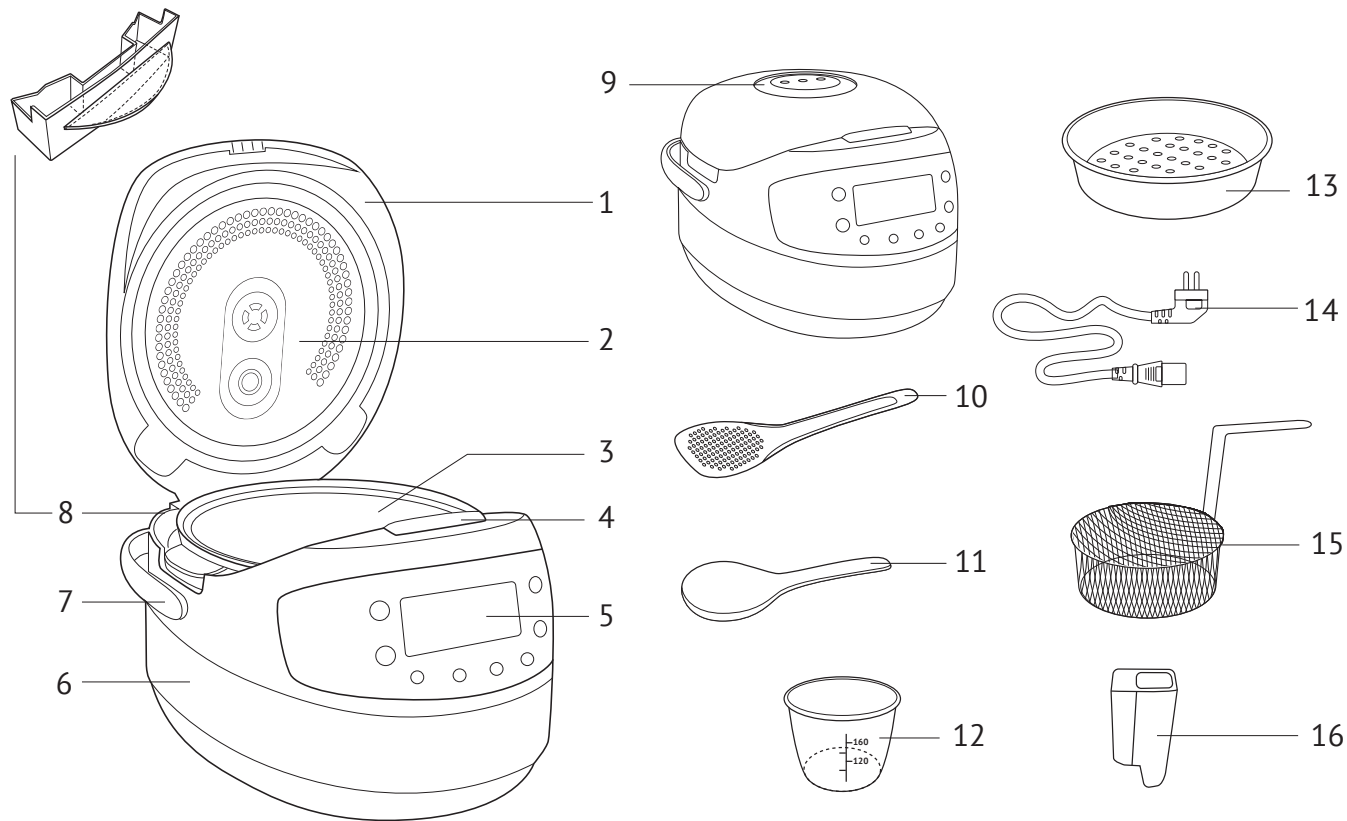

A2

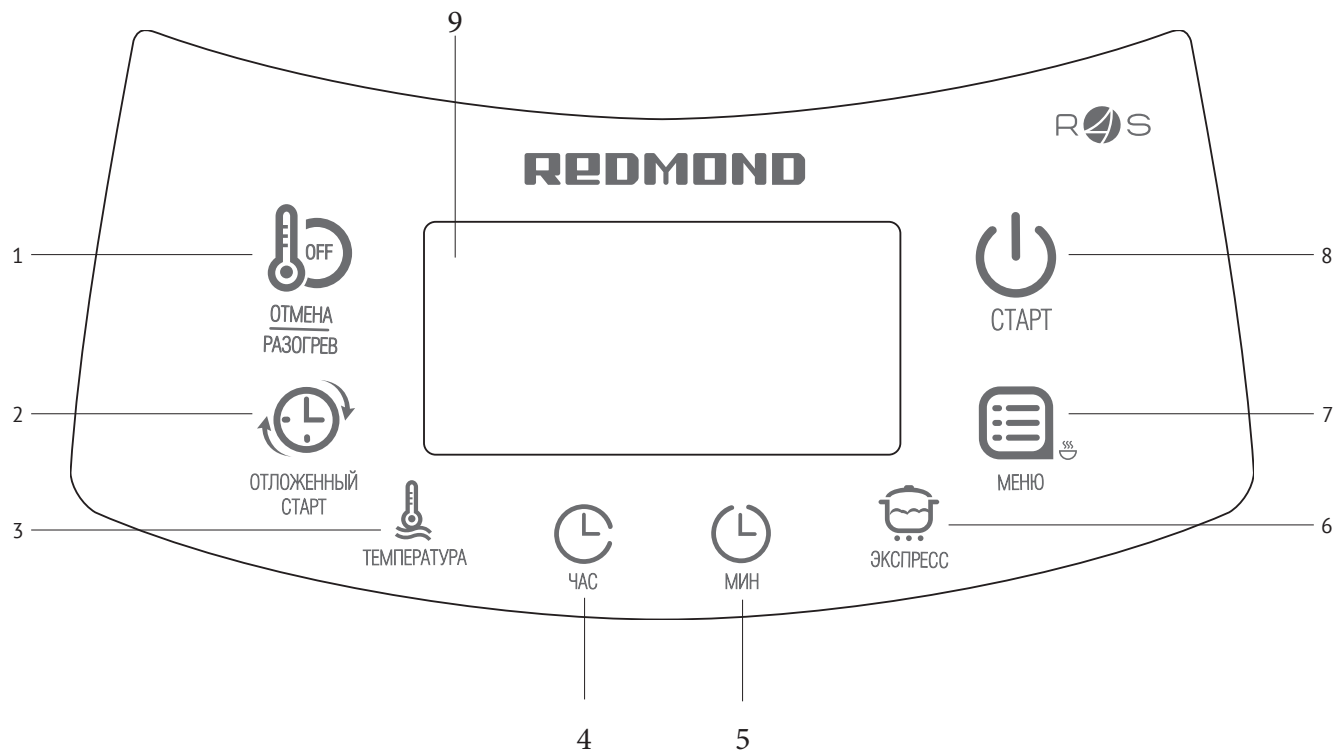

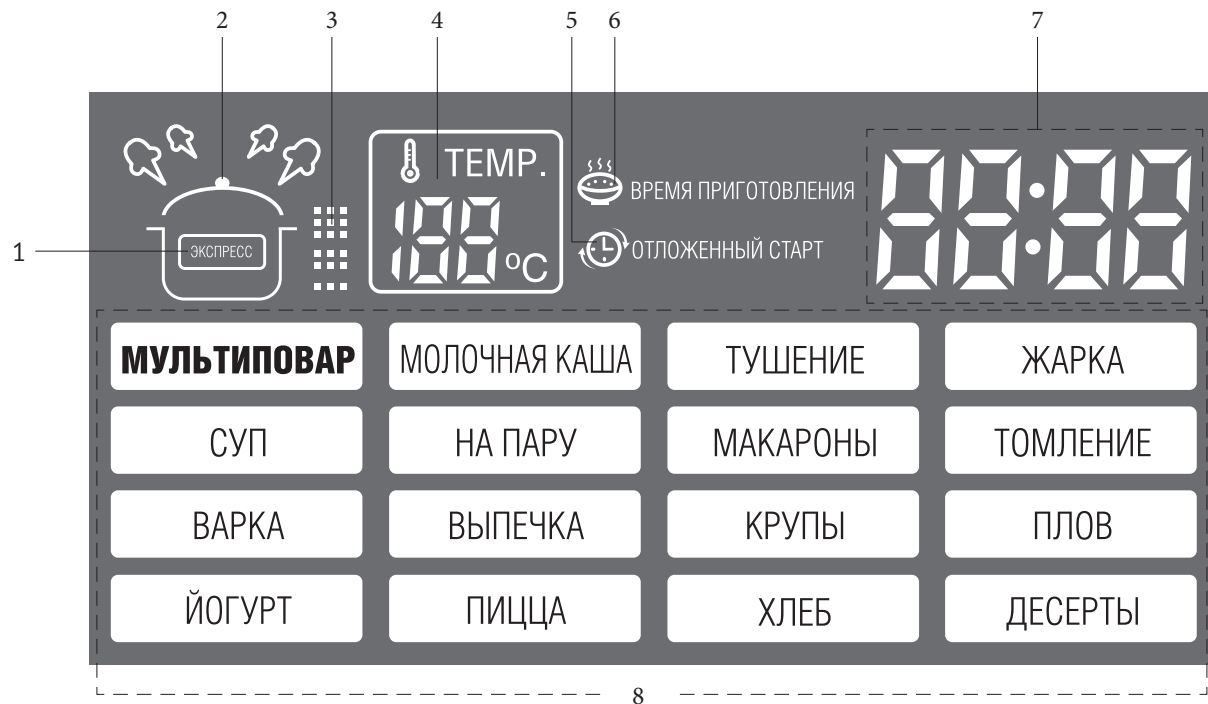

A4

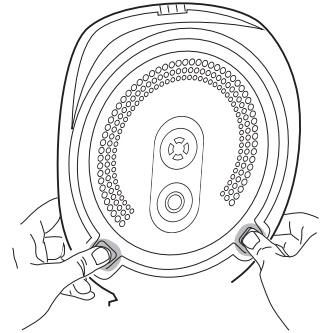
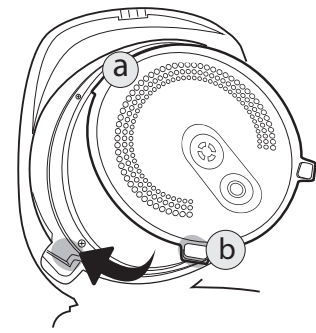
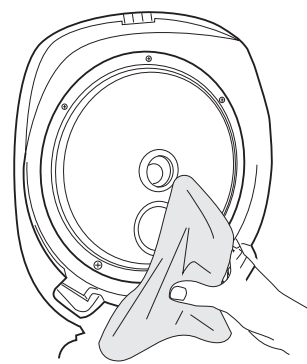
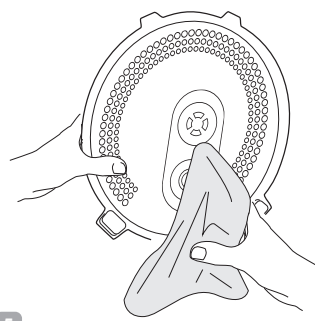
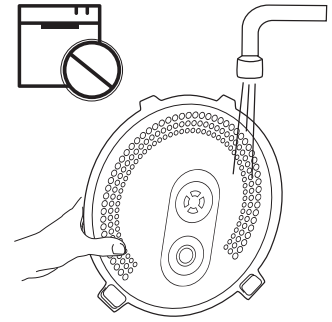
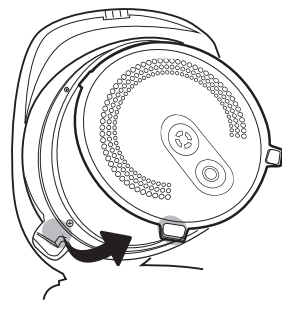
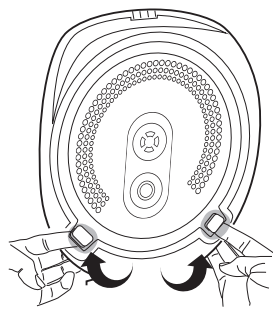
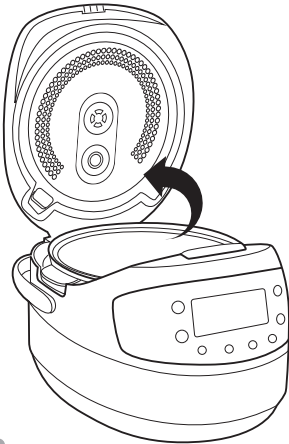

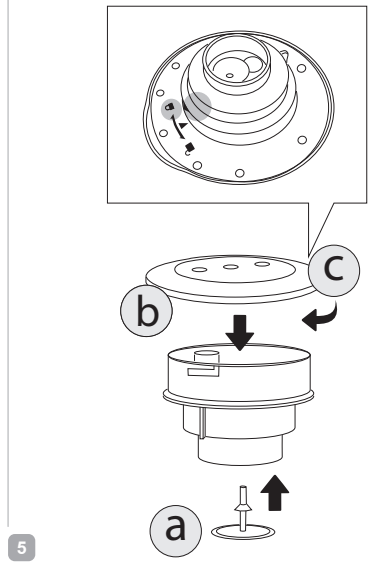
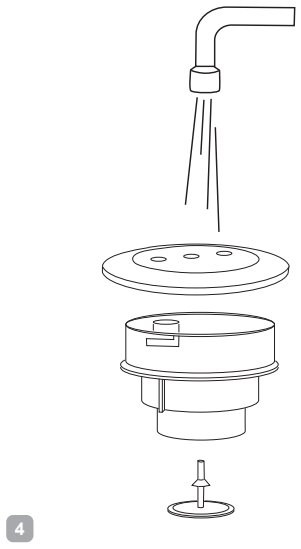
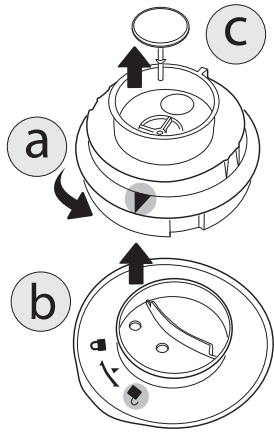
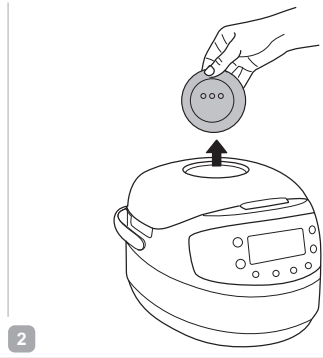

 Carefully read all instructions before operating and save them for future reference. By carefully following these instructions you can considerably prolong the service life of your appliance.

The safety measures and instructions contained in this manual do not cover all possible situations that may arise during the operation of the appliance. When operating the device the user should be guided by common sense, be cautious and attentive.

IMPORTANT SAFEGUARDS

- The manufacturer shall not be responsible for any failures arising from the use of this product in a manner inconsistent with the technical or safety standards.
 - This appliance is a multifunctional appliance and is intended to be used for nonindustrial use in household and similar spheres of application: at home kitchens, country houses and other residential environments. Industrial application or any other misuse will be regarded as violation of proper service conditions. Should this happen, manufacturer shall not be responsible for possible consequences.
 - Before plugging in the appliance ensure that the circuit voltage matches operating voltage of the appliance (see technical specifications or manufacturer's plate on the appliance).
 - Use an extension cord designed for power consumption of the appliance as the parameter mismatch may result in a short circuit or fire outbreak.
 - The appliance must be grounded. Connect the appliance only to a properly installed power point. Failure to do so may result in the risk of electrical shock. Use only grounded extension cords.
-  **CAUTION!** While in use the appliance heats up! Care should be taken to avoid touching the housing, bowl, or any other metal parts while operating. Make sure your hands are protected before handling the device. To avoid burns, do not lean over the appliance while opening the lid.
- Unplug the appliance after use, before cleaning or moving. Remove the power cord with dry hands holding it by the plug, not cord.

- Do not place the cord in doorframes or by heat sources. Do not twist or bend the power cord, ensure it is not in contact with sharp objects, corners and edges of furniture.

 **PLEASE NOTE:** *damaging the cord may lead to a failure that will not be covered by the warranty. If the cable is damaged or requires replacing, contact an authorized service center to have the cord replaced.*

- Never place the device on soft surfaces or cover it to keep ventilation slots clear of any obstruction.
- Do not operate the appliance outdoors to prevent water or any foreign object or insect from getting into the device. Doing so may result in serious damage of the appliance.
- Use the appliance at an altitude of no more than 2000 m.
- Always unplug the device and let it cool down before cleaning. Follow cleaning and general maintenance guidelines when cleaning the unit.

 **DO NOT immerse the device in water or wash it in running water!**

- This appliance can be used by children aged from 8 years and above and persons with reduced physical, sensory or mental capabilities or lack of experience and knowledge if they have been given supervision or instruction concerning use of the appliance in a safe way and understand the hazards involved. Children shall not play with the appliance. Keep the appliance and its cord out of reach of children aged less than 8 years. Cleaning and user maintenance shall not be made by children without supervision.
- Keep packaging (film, foam plastic and other) out of reach of children as they may choke on them.
- No kind of modification or adjustment to the product is allowed. All the repairs should be carried out by an authorized service center. Failure to do so may result in the device breakage, property damage or physical injury.

 **CAUTION!** Do not use the appliance in case any defect has been noticed.

Technical Specifications

Model.....	SkyCooker RMC-M92S
Power.....	860-1000 W
Voltage.....	220-240 V, 50/60 Hz
Electric shock hazard protection.....	class I
Remote control.....	Ready for Sky technology
Data communication protocol.....	Bluetooth v4.0
Supported operating systems.....	Android, iOS
Bowl capacity.....	5 L
3D heating.....	yes
Bowl coating.....	ceramic non-stick by ANATO®
Display.....	LED
Steam valve.....	removable
Inner lid.....	removable
Overall dimensions.....	377 × 285 × 240 mm
Net weight.....	3.5 kg

Programs

1. МУЛЬТИПОВАР (MULTI COOK)	6. НА ПАРУ (STEAM)	12. ПЛОВ (PILAF)
2. МОЛОЧНАЯ КАША (OATMEAL)	7. МАКАРОНЫ (PASTA)	13. ЙОГУРТ (YOGURT/ DOUGH)
3. ТУШЕНИЕ (STEW)	8. ТОМЛЕНИЕ (SLOW COOK)	14. ПИЦЦА (PIZZA)
4. ЖАРКА (FRY)	9. ВАРКА (BOIL)	15. ХЛЕБ (BREAD)
5. СУП (SOUP)	10. ВЫПЕЧКА (BAKE)	16. ДЕСЕРТЫ (DESSERT)
	11. КРУПЫ (GRAIN)	17. ЭКСПРЕСС (EXPRESS)

Functions

The Ready for Sky technology (remote control).....	yes
Keep Warm function.....	up to 12 hours
Disabling Keep Warm in advance.....	yes
Reheat function.....	up to 12 hours
Time Delay function.....	up to 24 hours

Package includes

Multicooker.....	1 pc.
Bowl.....	1 pc.
Steaming container.....	1 pc.
Measuring cup.....	1 pc.
Serving spoon.....	1 pc.
Stirring paddle.....	1 pc.
Spoon/paddle holder.....	1 pc.
Deep fry basket.....	1 pc.
Cookbook.....	1 pc.

User manual.....	1 pc.
Service booklet.....	1 pc.
Power cord.....	1 pc.

In accordance with the policy of continuous improvement, the manufacturer reserves the right to make any modifications to design, packaging arrangement, or technical specifications of the product without prior notice. The specification allows an error of ±10%.

Multicooker parts **A1**

1. Main lid	9. Removable steam valve
2. Removable inner lid	10. Stirring paddle
3. Bowl	11. Serving spoon
4. Lid release button	12. Measuring cup
5. Control panel with display	13. Steaming container
6. Housing	14. Power cord
7. Carrying handle	15. Deep fry basket
8. Condensate container	16. Spoon/paddle holder

Control panel **A2**

1. "Отмена/Разогрев" (Reheat/Cancel) button disables/reactivates the Reheat function, interrupts the program and cancels all settings.
2. "Отложенный старт" (Time Delay) button is used to enter the time setting mode in Time Delay function, to enable/disable Bluetooth
3. "Температура" (Temperature) button is used to adjust the temperature.
4. "Час" (Hour) button is used to adjust the hours.
5. "Мин" (Min) button is used to adjust the minutes in time setting Time Delay modes.
6. "Экспресс" (EXPRESS) button starts "ЭКСПРЕСС" program.
7. "Меню" (Menu) button is used to select an automatic cooking program and to disable the Keep Warm function in advance.
8. "Старт" (Start) button starts the cooking program.
9. Display.

Display **A3**

- | | |
|--|---|
| 1. "ЭКСПРЕСС" program indicator | 5. Time Delay indicator |
| 2. Operating program / Reheat function indicator | 6. Cooking program operation indicator. |
| 3. Cooking stage indicator | 7. Time value indicator. |
| 4. "МУЛЬТИПОВАР" temperature indicator | 8. Cooking program indicators. |

I. PRIOR TO FIRST USE

Carefully remove the unit and its accessories from the packaging. Dispose of all packaging materials and promotional stickers.

⚠ *Keep all warning labels, warning stickers (if any), and the serial number identification label located on the housing.*

After transportation or storage at low temperature allow the appliance to stay at room temperature for at least 2 hours before use.

Wipe the housing with a damp cloth, rinse the bowl with warm water, and let dry. To eliminate unwanted odour during the first use thoroughly clean the appliance following the procedure outlined in the Cleaning and Maintenance section of this manual.

Place the appliance on a flat, stable, and horizontal surface away from wallpaper, decorative coatings, electronic appliances, or any other objects or cabinets that could be damaged by steam, humidity, or high temperature.

Before operating, make sure that the outer and inner parts of the pressure multicooker have no dents, cracks or any other visible damages. There should not be any obstructions between the heating element and the bowl.

- STOP** *ATTENTION! It is forbidden to lift the device with the filled bowl by the handle. ATTENTION! It is forbidden to lift the device by the handles of the bowl!*

Do not switch the device on without the inside of the bowl or empty bowl – in case of accidental start of the cooking program it will lead to a critical overheating of the device or damage the non-stick coating. Before frying products, pour a little vegetable or sunflower oil into the bowl.

II. OPERATION

The Ready for Sky technology



The Ready for Sky technology enables to use the software app of the same name to control the appliance remotely from a smartphone or tablet.

1. Download the software from the App Store or Google Play (depending on your operating system) onto your smartphone or tablet.

i *For the minimum supported OS version, see the company's official website www.redmond.com or the application description at the App Store and Google Play.*

2. Open the Ready for Sky app, create an account, and follow the prompts that appear on the screen.
3. Enable the Bluetooth function on the appliance. To do this, press and hold down the TimeDelay button, the beep will be supplied, and the button indicator will come on. The appliance should be in the standby mode (the display is not illuminated).

⚠ *The remote control of SkyCooker RMC-M92S-E is only possible when the Bluetooth function is on (the "Отложенный старт" button indicator in standby mode is always on).*

4. Press and hold down the "Час" button for 5 seconds on the control panel of the multicooker. The appliance should be in the standby mode (the display is not illuminated).
5. The changing symbols  and  will be displayed during connection on the multicooker display. After the connection is made an audible signal will be heard and appliance will switch to the standby mode.

6. To disable the multicooker from the mobile device press and hold down the "Мин" button until an audible signal is heard, when the multicooker is in the standby mode.
7. To turn off the Bluetooth function, in the standby mode of the appliance press and hold down the "Отложенный старт" button, the button indicator will go off.

i *To provide stable connection the mobile device should be located within no more than 15 metres from the appliance.*

Appliance control via the wireless network. Instruction on the R4S Gateway application installation is available through the link: www.readyforsky.com/r4sgateway

Non-volatile memory

REDMOND SkyCooker RMC-M92S-E has a non-volatile memory. In the event of a power outage while the cooking program is running, the settings are stored in the appliance's memory. When the power is restored, the display will remain on until the power is turned off.

i *If the temperature difference in the bowl is less than 5°C when the power is switched off and on, the appliance will continue to operate.*

If the temperature difference is greater than 5°C, the program will be paused – the time indicator and the running program indicator will flash on the display. There is no countdown of cooking time. At the same time, once a minute for half an hour 1 beep will sound.

To continue the cooking process, press and hold down the "Старт" button. The cooking time indicator will be on continuously. The countdown will continue.

If the cooking process does not continue for 30 minutes, the appliance will go into the standby mode. Press and hold down the "Отмена/Разоррев" button to stop the cooking indicator from blinking.

If the power supply is turned off during the time delay operation, the display will remain on when the power is turned on until the time delay function indicator flashes, the cooking program will continue to work.

To interrupt the time delay, press and hold down the "Отмена/Разоррев" button.

Setting The Cooking Time

The multicooker allows manually adjusting the cooking time, set by default for each program (except "ЭКСПРЕСС"). Time adjustment range and interval depend on the program of cooking selected.

The time indicator will start flashing when the cooking program is selected. To increase the hour value press the "Час" button, to increase the minute value – the "Мин" button. Press and hold the corresponding button down to scroll through the digits.

i *In certain automatic programs countdown starts only when the device reaches its operating temperature. E.g. If you set "ТУШЕНИЕ" program on 5 minutes, the countdown of the program begins only when the water comes to a full boil providing enough steam.*

In "МАКАРОНЫ" program, the countdown begins after water starts boiling and "Старт" button is being repressed.

Time Delay Function

This function allows setting the program to finish by certain time. Cooking time may be delayed for a period from 10 minutes to 24 hours with 10 minute intervals. Setting Time Delay function, take the cooking time of the program into consideration. The time of a delay should be longer than the cooking time of the program selected; otherwise the program starts running right after you press "Старт".

To set the time of delay press the "Отложенный старт" button after the program selection. To increase the hour value press the "Час" button, to increase the minute value – the "Мин" button. Press and hold the corresponding button down to scroll through the digits.

i Time Delay function is available in all automatic programs except "ЖАРКА", "МАКАРОНЫ" and "ЭКСПРЕСС".

It is not recommended to use Time Delay function if dairy and other perishable products are being used (eggs, fresh milk, meat, cheese etc.).

Keep Warm Function

Function is being automatically activated at the end of the cooking program. When the program finishes, the temperature of the meal (70–75°C) is being maintained for a period of time up to 12 hours. The Reheat/Cancel indicator is lit with the enabled Keep Warm, the direct counting of the program time in this mode is displayed.

Keep Warm may be disabled if necessary by pressing and holding the "Отмена/Разогрев" button until an audible signal is heard.

i The function is not applicable in "МАКАРОНЫ", "ЙОГУРТ" and "ЭКСПРЕСС" programs.

When setting the cooking temperature below 80°C in the "МУЛЬТИПОВАР" program the Keep Warm function will be disabled by default. To enable Keep Warm press and hold down the "Меню" button during program operation.

Disabling The Keep Warm In Advance

Automatic activation of the Keep Warm function at the end of the program may sometimes be undesirable. The multicooker allows disabling the function in advance, while setting the program or during its operation. Press and hold down the "Меню" button to cancel the function. "Отмена/Разогрев" button indicator goes off. To reactivate the function, repress and hold down the "Меню" button ("Отмена/Разогрев" button indicator goes off).

Reheat Function

The multicooker can be used for warming up cold meals. To reheat:

1. Put the products into the bowl. Place the bowl inside the device.
2. Close the lid until it clicks into place and plug in the unit.
3. Press and hold down "Отмена/Разогрев" button for a few seconds until an audible sound is produced. Corresponding indicators light up and reheating process begins. The timer starts its countdown.

The meal will be warmed up to 70–75°C and the temperature will be maintained for the next 12 hours. To cancel the function press and hold down "Отмена/Разогрев" button. Corresponding indicators go off.

i The function may operate for a period of 12 hours, however, we recommend using it moderately, because a prolonged thermal exposure may sometimes affect flavor characteristics of the meal.

Standard Operating Procedure for Automatic Programs

⚠ IMPORTANT! When using the water boiling device (for example, when boiling products), DO NOT set the cooking temperature above 100°C. It may result in overheating and failure of the device. For the same reason, DO NOT use the "БЫПЕЧКА", "ЖАРКА" and "ХЛЕБ" programs to boil water.

1. Measure the ingredients according to the recipe.
2. Put them into the bowl. Make sure that all the ingredients including liquid are below the scale mark indicating maximum capacity. Place the bowl inside the device. The bowl and the heating element must fit tightly.

STOP Use only the bowl supplied or compatible with this model when using the multicooker. See www.redmond.company for compatible bowls. DO NOT use any other utensils!

DO NOT process food directly in the bowl! This may damage the non-stick coating, deform the bowl and damage the appliance.

3. Close the lid until it clicks into place. Plug in the unit.
- ⚠** ATTENTION! If you cook at high temperatures using a large amount of vegetable oil, always leave the lid of the device open.
4. Repeatedly press "Меню" button to select the program (corresponding indicator lights up).
- i** To start the "ЭКСПРЕСС" program from the standby mode press and hold down the "Экспресс" button, until the "ЭКСПРЕСС" indicator lights up on display. During this program operation the program countdown is not displayed.
5. The "МУЛЬТИПОВАР" program provides the cooking temperature adjustment before the start of the program (default temperature is 100°C). Set the desired value by pressing the "Температура" button.

6. You can adjust cooking time value.
7. Set time of delay if necessary.
8. Press and hold for several seconds the "Старт" button to begin cooking cycle. Start and Reheat/Cancel indicators will light up solid. Depending on the selected cooking program the countdown will start immediately or after water in the bowl comes to the boil.

i When using the "МАКАРОНЫ" program an audible signal will inform you of water boiling and the necessity of adding the ingredients. The time starts to countdown after repressing "Старт".

9. To preliminarily disable the Keep Warm function, press and hold down the "Меню" button (the ("Отмена/Разогрев" button indicator will go out). You may re-enable this function by repressing the "Меню" button.
10. An audible signal will be produced to indicate that cooking cycle is complete. Depending on selected programme or current settings the appliance will either enter Keep Warm (Reheat/Cancel is lit on the display) or Standby mode "Старт" button indicator is flashing).

i To interrupt cooking process at any stage, to cancel set program or the Keep Warm function press and hold down "Отмена/Разогрев" button.

📖 For high-quality results, you are offered to use the recipes for cooking from the cook book supplied with REDMOND multicooker SkyCooker RMC-M92S-E, designed specifically for this model.

💡 If you did not achieve the desired result using automatic programs, try versatile program called "МУЛЬТИПОВАР", featuring a wide time and temperature adjustment range. This program gives endless opportunities for new culinary experiments.

Table of Default Settings

Program	Recommendations for use	Countdown after boiling	Default cooking Time	Time range/interval	Time Delay, h	Keep Warm, h
МУЛЬТИПОВАР	Cooking various meals with your personal time and temperature settings. Temperature adjustment range is from 35 to 170°C with 1°C intervals		30 min	5 min – 1 h / 1 min 1 h – 12 h / 5 min	24	12
МОЛОЧНАЯ КАША	Cooking porridges using milk		10 min	5 min – 1 h 30 min / 1 min	24	12
ТУШЕНИЕ	Stewing meat, fish, vegetables, etc.		1 h	10 min – 12 h / 5 min	24	12
ЖАРКА	Frying meat, fish, vegetables, etc.		15 min	5 min – 1 h 30 min / 1 min		12
СУП	Making various soups and broths		1 h	10 min – 8 h / 5 min	24	12
НА ПАРУ	Steaming meat, fish, vegetables, etc.	✓	20 min	5 min – 2 h / 5 min	24	12
МАКАРОНЫ	Cooking pasta, sausages and other semi-finished products. An audible signal will be heard when water comes to a boil. Press "Start" button again to begin the countdown	✓	8 min	2 min – 1 h / 1 min		
ТОМЛЕНИЕ	Making stewed meat, baked milk, brisket, jellied meat and aspic		5 h	30 min – 12 h / 10 min	24	12
ВАРКА	Cooking beans and vegetables		40 min	10 min – 12 h / 5 min	24	12
ВЫПЕЧКА	Baking cakes, puddings, pies, puff and yeast pastry		1 h	10 min – 8 h / 5 min	24	4
КРУПЫ	Cooking grains and other side dishes		35 min	5 min – 4 h / 5 min	24	12
ПЛОВ	Making meat, fish, poultry and seafood pilafs		1 h	10 min – 1 h 30 min / 10 min	24	12
ЙОГУРТ	Making different kinds of yogurt; proofing dough		8 h	10 min – 12 h / 10 min	24	
ПИЦЦА	Making pizza		25 min	10 min – 1 h / 5 min	24	4
ХЛЕБ	Baking white and wheat-rye breads including the proofing cycle		3 h	1 h – 6 h / 10 min	24	3
ДЕСЕРТЫ	Making desserts using fresh fruits and berries		20 min	5 min – 2 h / 5 min	24	12

Program	Recommendations for use	Countdown after boiling	Default cooking Time	Time range/interval	Time Delay, h	Keep Warm, h
ЭКСПРЕСС	Quick cooking rice and other grains			Automatic shut-off after boiling of water		

STOP If you use the "МУЛЬТИПОВАР" program for boiling the water (for example, when cooking products), it is FORBIDDEN to set the cooking temperature above 100°C.

III. ADDITIONAL FEATURES

- Proofing Dough
- Making Fondue
- Making Cheese, Cottage Cheese
- Deep frying
- Making khalvah
- Sterilizing tableware
- Pasteurizing liquid foods
- Baby food heating

💡 You may find recipes of the dishes, indicated in the section in the cookbook or on website www.redmond.company.

IV. COOKING TIPS

Common Cooking Mistakes and Ways of Solving Them

This table familiarizes you with the practical tips and solutions to some common problems you may experience when using the multicooker.

THE DISH IS UNDERCOOKED

Possible causes	Solutions
The lid of the device was open or was not closed properly, so the cooking temperature was not high enough	Try to avoid opening the lid while cooking. Close the lid until it clicks into place. Make sure that the rubber sealing ring located on the inner side of the lid is not deformed or damaged in any way
Cooking temperature was not observed because the bowl and the heating element did not fit tightly	There should not be any foreign objects between the lid and the housing of the device, remove if any. Always make sure that the heating element is clean and fits tightly with the bowl before cooking
Wrong ingredients or settings were chosen. General proportions were not observed, the foods were cut into pieces that are a bit too big. Wrong time settings. Chosen recipe is not appropriate for the appliance	We recommend that you use recipes adapted for the device. Choose proven recipes only. Set the time and cooking programme, choose ingredients, proportions, and the size of pieces according to the recipe
Steaming: the amount of water in the bowl is not enough to provide enough steam density	Use the amount of water recommended. If in doubt, check the water level while steaming

Possible causes		Solutions
Frying	Too much vegetable oil was added	For regular frying add an amount of vegetable oil just enough to cover the bottom of the bowl. Follow recommendations given in the recipe while deep frying
	Too much liquid inside the bowl	Do not close the lid of the device while frying unless specified in the recipe. Defrost and let drain the ingredients before frying
Boiling: the broth boiled away while cooking acidic foods		Certain foods need to be washed or sautéed before cooking. Follow recommendations given in the recipe
Baking (dough failed to bake through)	While proving the dough has reached the inner lid and covered the steam valve	Use a smaller amount of dough
	Too much dough in the bowl	Take the product out of the bowl, turn it over and place back. Bake until ready, next time use smaller amount of dough

THE DISH IS OVERCOOKED

Wrong ingredients or time settings, the foods were cut into pieces that are a bit too small	We recommend that you use the recipes adapted for your model. Set the time and cooking programme, choose ingredients, proportions and the size of the pieces according to the recipe
The dish was in the bowl on the Keep Warm function for too long after being cooked	We recommend that you use the Keep Warm function mode moderately. If your device enables you to switch Keep Warm off in advance, use it to avoid the problem

LIQUID BOILS AWAY WHILE COOKING

Milk boils away	Depending on both quality and properties of the milk used, it may boil away. To avoid this, we recommend that you use only ultra-pasteurized skimmed milk. Mix the milk with some water if needed
Foods were not properly processed (were not rinsed well, etc.). Wrong general proportions or ingredients	We recommend that you use the recipes adapted for the device. Try choosing proven recipes only. Set the time and cooking programme, choose ingredients, proportions, and the size of the pieces according to the recipe. Whole grains, meat, fish, and seafood need to be thoroughly rinsed before cooking

THE DISH GETS BURNT

The bowl was not properly washed before cooking. Non-stick coating is damaged	Before cooking ensure that the bowl is clean and has no coating defects
General amount of ingredients is smaller than recommended	Use proven recipes adapted for the device
Cooking time was too long	Reduce the cooking time or follow recommendations given in the recipe adapted for your model
Frying: oil was not added; the ingredients have not been stirred or turned over	For regular frying add an amount of vegetable oil just enough to cover the bottom of the bowl. For proper frying stir or turn the ingredients occasionally in the bowl while cooking

Stewing: not enough liquid	Add more liquid. Avoid opening the lid while cooking
Boiling: not enough liquid in the bowl (proportions were not observed)	Follow recommended amounts of liquids and solids while cooking
Baking: the bowl was not greased before baking	Grease the bottom and sides of the bowl with butter or vegetable oil before baking (do not pour oil inside)

INGREDIENTS LOSE THEIR SHAPE WHEN COOKED

The ingredients have been stirred a bit too often	While frying foods, it is enough to stir the ingredients every 5-7 minutes
Cooking time was too long	Reduce cooking time or follow recommendations given in the recipe adapted for the device

PASTRY IS DAMP

Improper ingredients were used (juicy fruit or vegetables, frozen berries, sour cream, etc.)	Use ingredients according to the recipe. Avoid using ingredients that contain excess moisture or use them in smaller amounts
The baked product has been left in the multicooker with the closed lid for too long	We recommend that you take the baked product out of the bowl right after the baking cycle is over or leave it on Keep Warm mode for a short period of time only

PASTRY WON'T RISE

Eggs and sugar were not whisked well	Use proven recipes adapted for the device. Choose, measure and process the ingredients according to the recommendations given in the recipe
The dough sat for too long before being baked	
The flour wasn't sifted or the dough was not kneaded well	
Wrong ingredients	
Wrong recipe	

- i** Certain REDMOND multicookers feature overheat protection in the "ТУШЕНИЕ" and "СУП" programmes. In case there is not enough liquid in the bowl, the appliance activates overheat protection, automatically interrupts the programme, and switches to the Keep Warm.

Recommended Steaming Time Settings For Various Products

(for 500 g of product with the volume of water 600–1000 ml)

Product	Cooking time, min	Product	Cooking time, min
Pork/beef fillet (cut into 1.5 cm cubes)	20/30	Dumplings/Khinkali	20
Mutton fillet (cut into 1.5 cm cubes)	30	Potatoes (cut into 1.5 cm cubes)	20
Chicken fillet (cut into 1.5 cm cubes)	15	Carrots (cut into 1.5 cm cubes)	30
Meatballs/cutlets	15/20	Beet (cut into 1.5 cm cubes)	80
Fish fillet	10	Frozen vegetables	15
Shrimps (cooked, peeled, frozen)	5	Egg	10

i Please note that these are only approximate guidelines. Steaming times may vary, depending on the quality of foods and your personal preferences.

Recommended Temperatures in “МУЛЬТИПОВАР”

Temperature, °C	Recommendations for use	Temperature, °C	Recommendations for use
35	Proofing dough and making vinegar	105	Cooking jellied meat
40	Making yogurts	110	Sterilization
45	Leavening	115	Making sugar syrup
50	Fermentation	120	Making brisket
55	Fondant	125	Stewing meat
60	Making green tea and preparing baby food	130	Making puddings
65	Cooking vacuum sealed meat	135	Browning cooked foods
70	Preparing punch	140	Smoking various foods
75	Pasteurizing liquids and making white tea	145	Baking fish and vegetables in foil
80	Preparing mulled wine	150	Baking meat in foil
85	Making cottage cheese and other time consuming meals	155	Frying yeast dough
90	Making red tea	160	Frying poultry
95	Cooking porridges using milk	165	Frying steaks
100	Cooking meringues and jams	170	Deep frying French fries and chicken nuggets

V. CLEANING AND MAINTENANCE

General Guidelines

- Before the first use of the multicooker or to eliminate smell of food after cooking, it is recommended to pour 0.5 l of water into the bowl and process half of the lemon cut into slices inside the bowl for 15 minutes using the “HA ПИПУ” program.
- Do not leave cooking bowl with foods or liquids inside closed multicooker for over 24 hours. Store cooked foods in refrigerator and reheat when required, using Reheat function.
- If not in use for an extended period of time, unplug the appliance. Cooking chamber, heating disc, cooking bowl, inner lid and steam valve must be dry and clean.
- Before you start cleaning the appliance, make sure that it is unplugged and has completely cooled down. Use soft cloth and mild soap to clean.

⚠ DO NOT use a sponge or tissue with hard or abrasive surface or abrasive pastes. DO NOT use any chemically aggressive substances or any other agents which are not recommended for cleaning items that come into contact with food.

STOP DO NOT immerse the appliance in water or wash under running water!

- Be careful when cleaning rubber parts of the multicooker, because damaged or deformed parts may lead to malfunction of the unit.
- Clean the housing when necessary. Cooking bowl, inner lid and removable steam valve need to be cleaned after each use. Condensate, accumulating during cooking, needs to be removed after each use. Clean the interior of the cooking chamber when necessary.

To Clean the Housing

Use soft damp cloth or sponge to clean the housing. If necessary, use a mild soap solution and wipe the surface dry to remove soap residue and water spots.

To Clean the Bowl

Wash the bowl by hand, using soft sponge and mild soap, or in a dishwasher (following its manufacturer’s recommendations). If necessary fill the bowl with warm water, let soak and clean. Wipe the outer surface of the bowl dry before positioning it back inside the multicooker. When the multicooker is used on a regular basis, inner non-stick coating of the bowl may partially or completely change color, which does not indicate a defect.

To Clean Inner Aluminium lid

To see the order of removal and adjustment of the inner aluminium lid ref to the scheme **A4**. To clean the main and removable inner lids use a damp kitchen cloth or a sponge. Before adjusting the inner lid wipe the surfaces of both lids dry.

To Clean Removable Steam Valve

Steam valve is located in the special slot on the inner surface of the lid. To see the cleaning order ref to the scheme **A5**.

STOP CAUTION! Do not twist or stretch sealing insert to avoid its deformation.

To Remove Condensate

Condensate accumulates in the special cavity on the housing around the bowl and flows into a special container in the back of the appliance. To clean the container rinse it under running water, following above mentioned rules. Remove the remaining condensate using a kitchen cloth.

To Clean Cooking Chamber

Compliance with the user manual guidelines minimizes the risk of food particles or liquids accumulating inside the cooking chamber. However, if the inside of the chamber gets dirty, clean it to prevent improper operation or malfunction of the unit.

STOP Before cleaning cooking chamber ensure, that the multicooker is unplugged and has completely cooled down!

Walls of the cooking chamber, surface of the heating disk, and the casing of central thermal sensor (located in the middle of the heating disk) can be cleaned with a damp (not wet!) sponge or cloth. Remove any traces of soap or detergent if using any to prevent unwanted odors during cooking.

If there is a foreign object in the cavity around central thermal sensor, carefully remove it using tweezers, trying to avoid pressing on the casing of the sensor. Clean heating disk with a damp medium-hard sponge or synthetic brush, if necessary.

i When the multicooker is used on a regular basis, heating disk may partially or completely change color, which does not indicate a defect and does not affect proper operation of the unit.

Transportation and Storage

Before repeated operation or storage completely dry all parts of the appliance. Store the assembled appliance in a dry, ventilated place away from heating appliances and direct sunlight. During transportation and storage, do not expose the device to mechanical stress, that may lead to damage of the device and/or violation of the package integrity. Keep the device package away from water and other liquids.

VI. ADDITIONAL ACCESSORIES

Additional accessories for the multicooker and information on the innovations are available through www.redmond.company and our authorized dealers.

VII. BEFORE CONTACTING SERVICE CENTER

Problem	Possible cause	Solution
Display shows the error code: E1-E5	System error, possible control board or heating element malfunction	Unplug the appliance and let cool down. Close the lid tightly and plug in the appliance
Appliance does not switch on	Power cord is not connected to the appliance and/or socket	Ensure that the power cord is connected to the corresponding inlet on the housing of the appliance and to the socket
	Wall socket is not working properly	Connect to a properly working wall socket
	Power supply failure	Check the power supply. If not available, contact local electricity supply company
Dish is taking too long to cook	Power supply interruption (power supply is unstable/underrated)	Ensure that the power supply is stable. If unstable / underrated, contact local electricity supply company
	There is a foreign object between the bowl and the heating element (grain, food particles, debris, etc.)	Unplug the appliance and let cool down. Remove foreign object or objects
	The bowl is not properly positioned	Properly position the bowl into place
	Heating disk is dirty	Unplug the appliance and let cool down. Clean heating disk
Hot steam escapes from under lid during cooking	Inner lid and cooking bowl fail to seal hermetically	The bowl is not properly positioned Properly position the bowl into place
		The lid is not closed properly; foreign object under lid Remove foreign objects (grain, food particles, debris, etc.) from under the rim, if any. Always close the lid until it clicks into place

Problem	Possible cause	Solution
Hot steam escapes from under lid during cooking	Inner lid and cooking bowl fail to seal hermetically	Sealing ring is dirty, deformed, or damaged in any way Check the sealing ring. Replace, if necessary
The attempt of synchronization or transferring the data from the appliance to the mobile device failed (error message will be displayed).	Bluetooth function on the mobile device is disabled	Enable Bluetooth function on the mobile device
	Ready for Sky app on the mobile device is deactivated	Run the Ready for Sky app on the mobile device
	The multicooker and mobile device are far away from each other or there are strays for the radio signal.	Ensure the distance between devices does not exceed 15 metres and there are no strays for transmission of radio signal.

i Note! In case any failure occur in the operation of the Ready for Sky app, it is not obligatory to apply to the service centre. Apply to REDMOND technical support service and obtain the consultation of our specialists on error elimination and/or failure in Ready for Sky operation. Your comments and suggestions concerning application operation will be taken into account upon successive update. Contact data of user support service of REDMOND appliances can be found in your country on the website www.redmond.company. You may also obtain the help, filling the contact form provided on the website.

In case you didn't manage to eliminate the defects, please, refer to the authorized service centre.



Environmentally friendly disposal (WEEE)

The packaging, user manual and the device itself shall be taken to the applicable collection point for the recycling of electrical and electronic equipment. Do not throw away the electronic waste to help protect the environment.

Old appliances must not be disposed with other household waste but must be collected separately. Municipal disposal of recyclable wastes is free of charge. The owners of old appliances are required to bring it to a waste facility centre. With this little extra effort, you can help to ensure that valuable raw materials are recycled and pollutants are treated as appropriate.

This appliance is labelled in accordance with European Directive 2012/19/EU – concerning used electrical and electronic appliances (waste electrical and electronic equipment WEEE). The guideline determines the framework for the return and recycling of used appliances as applicable throughout the EU.

Bluetooth is the registered trademark of Bluetooth SIG, Inc.

App Store is the service mark of Apple Inc., registered in the USA and other countries.

Google Play is the registered trademark of Google Inc.

www.redmond.company
www.multivarka.pro
www.store.redmond.company
www.smartredmond.com
Made in China

RMC-M92S-ENG-UM-1